

# Shelly<sup>®</sup> EM

## 2 Channel WiFi Energy Meter

### USER GUIDE

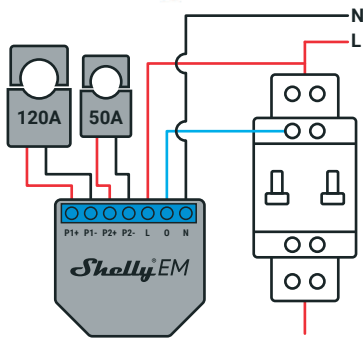

#### LEGEND:

- N** - Neutral input (110-230V AC);
- L** - Line input (110-230V AC);
- O** - Output for contactor control (max 2A);
- P1+** - Positive connection of current transformer 1
- P1-** - Negative connection of current transformer 1
- P2+** - Positive connection of current transformer 2
- P2-** - Negative connection of current transformer 2

The Dual WiFi Energy Meter, Shelly<sup>®</sup> EM by Allterco Robotics is intended to be mounted into a standard in-wall console or next to the breakers, in order to monitor the electric power through it, independent for each channel and heavy-duty contactor control. Shelly may work as a standalone Device or as an accessory to a home automation controller.

- Purpose of control: Operating
- Construction of control: Independently mounted
- Type 1.B Action
- Pollution Degree 2
- Impulse Voltage: 4000 V

### Specification

- Power supply:** 110-230V ±10% 50/60Hz AC
- Max measurement per channel:** 120A/230V
- Relay Max Load:** 2A/230V
- Complies with EU standards:**
  - RE Directive 2014/53/EU
  - LVD 2014/35/EU
  - EMC 2004/108/WE
  - RoHS2 2011/65/UE
- Working temperature:** - 40°C up to 40°C
- Radio signal power:** 1mW
- Radio protocol:** WiFi 802.11 b/g/n
- Frequency:** 2400 - 2500 MHz;
- Operational range (depending on local construction):**
  - up to 50 m outdoors
  - up to 30 m indoors
- Dimensions(HxWxL):** 39 x 36 x 17 mm
- Electrical consumption:** < 1 W

### Technical Information

- Control through WiFi from a mobile phone, PC, automation system or any other Device supporting HTTP and/or UDP protocol.
- Microprocessor management.

**⚠ CAUTION!** Danger of electrocution. Mounting the Device to the power grid has to be performed with caution.

**⚠ CAUTION!** Do not allow children to play with the button/switch connected the Device. Keep the Devices for remote control of Shelly (mobile phones, tablets, PCs) away from children.

#### Introduction to Shelly<sup>®</sup>

Shelly<sup>®</sup> is a family of innovative Devices, which allow remote control of electric appliances through mobile phone, PC or home automation system. Shelly<sup>®</sup> uses WiFi to connect to the devices controlling it. They can be in the same WiFi network or they can use remote access (through the Internet). Shelly<sup>®</sup> may work standalone, without being managed by a home automation controller, in the local WiFi network, as well as through a cloud service, from everywhere the User has Internet access.

Shelly<sup>®</sup> has an integrated web server, through which the User may adjust, control and monitor the Device. Shelly<sup>®</sup> has two WiFi modes - access Point (AP) and Client mode (CM). To operate in Client Mode, a WiFi router must be located within the range of the Device. Shelly<sup>®</sup> devices can communicate directly with other WiFi devices through HTTP protocol. An API can be provided by the Manufacturer. Shelly<sup>®</sup> devices may be available for monitor and control even if the User is outside the range of the local WiFi network, as long as the WiFi router is connected to the Internet. The cloud function could be used, which is activated through the web server of the Device or through the settings in the Shelly Cloud mobile application.

The User can register and access Shelly Cloud, using either Android or iOS mobile applications, or any internet browser and the web site: <https://my.Shelly.cloud/>.

#### Installation Instructions

**⚠ CAUTION!** Danger of electrocution! The mounting/ installation of the Device should be done by a qualified person (electrician).

**⚠ CAUTION!** Danger of electrocution! Do not connect the current transformer clamp to the Line, before wiring it to Shelly EM. Even if only the current transformer is connected, there might be high voltage across its connection cables.

**⚠ CAUTION!** Danger of electrocution. Even when the Device is turned off, it is possible to have voltage across its clamps. Every change in the connection of the clamps has to be done after ensuring all local power is powered off/disconnected.

**⚠ CAUTION!** Do not connect the Device to appliances exceeding the given max load!

**⚠ CAUTION!** Connect the Device only in the way shown in these instructions. Any other method could cause damage and/or injury.

**⚠ CAUTION!** Before beginning the installation please read the accompanying documentation carefully and completely. Failure to follow recommended procedures could lead to malfunction, danger to your life or violation of the law. Allterco Robotics is not responsible for any loss or damage in case of incorrect installation or operation of this Device.

**⚠ CAUTION!** Use the Device only with power grid and appliances which comply with all applicable regulations. Short circuit in the power grid or any appliance connected to the Device may damage the Device.

**⚠ RECOMMENDATION:** The Device may be connected to and may control electric circuits and appliances only if they comply with the respective standards and safety norms.

#### Initial Inclusion

**Initial Inclusion**  
Before installing/mounting the Device ensure that the grid is powered off (turned down breakers). Connect Shelly EM to the power grid and install it in the console following the scheme that suits the desired purpose.

You may choose if you want to use Shelly with the Shelly Cloud mobile application and Shelly Cloud service. You can also familiarize yourself with the instructions for Management and Control through the embedded Web interface.

#### Control your home with your voice

All Shelly devices are compatible with Amazon Echo and Google Home. Please see our step-by-step guide on: <https://shelly.cloud/compatibility/Alexa> <https://shelly.cloud/compatibility/Assistant>



### MOBILE APPLICATION FOR MANAGEMENT OF SHELLY<sup>®</sup>



Shelly Cloud gives you opportunity to control and adjust all Shelly<sup>®</sup> Devices from anywhere in the world.

You only need an internet connection and our mobile application, installed on your smartphone or tablet.

To install the application please visit Google Play (Android- fig. 3) or App Store (iOS - fig. 4) and install the Shelly Cloud app.



fig. 3

fig. 4

#### Registration

The first time you load the Shelly Cloud mobile app, you have to create an account which can manage all your Shelly<sup>®</sup> devices.

#### Forgotten Password

In case you forget or lose your password, just enter the e-mail address you have used in your registration. You will then receive instructions to change your password.

**WARNING!** Be careful when you type your e-mail address during the registration, as it will be used in case you forget your password.

After registering, create your first room (or rooms), where you are going to add and use your Shelly devices.

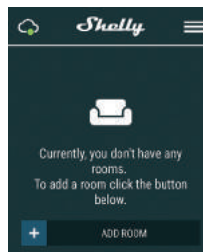

Shelly Cloud gives you opportunity to create scenes for automatic turning on or off of the Devices at predefined hours or based on other parameters like temperature, humidity, light etc. (with available sensor in Shelly Cloud). Shelly Cloud allows easy control and monitoring using a mobile phone, tablet or PC.

#### Device Inclusion

To add a new Shelly device, install it to the power grid following the Installation Instructions included with the Device.

#### Step 1

After the installation of Shelly in the console behind the power socket/light switch and the power is turned on Shelly will create its own WiFi Access Point (AP).

**WARNING:** In case the Device has not created its own WiFi network with SSID like **shellyem-35FA58** check if you have connected Shelly correctly by the schemes described above. If you do not see an active WiFi network with SSID like **shellyem-35FA58**, reset the Device. In order to reset the device, you will need physical access to it. On the back of the device, you will see a button. Press and hold it for 10 seconds. Shelly should return to AP Mode. If not, please repeat or contact our customer support at: [support@Shelly.cloud](mailto:support@Shelly.cloud)

#### Step 2

Choose "Add Device". In order to add more Devices later, use the app menu at the top right corner of the main screen and click "Add Device". Type the name (SSID) and password for the WiFi network, to which you want to add the Device.

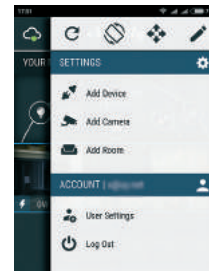

#### Step 3

If using iOS: you will see the following screen:

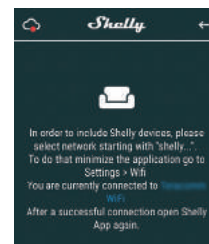

Press the home button of your iPhone/iPad/iPod. Open Settings > WiFi and connect to the WiFi network created by Shelly, e.g. **shellyem-35FA58**.

If using Android: your phone/tablet will automatically scan and include all new Shelly Devices in the WiFi network that you are connected to.



Upon successful Device Inclusion to the WiFi network you will see the following pop-up:

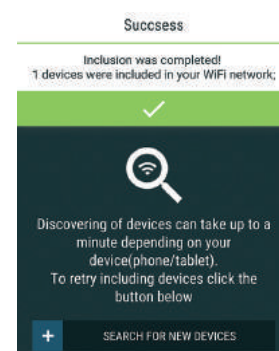

#### Step 4:

Approximately 30 seconds after discovery of any new Devices on the local WiFi network, a list will be displayed by default in the "Discovered Devices" room.

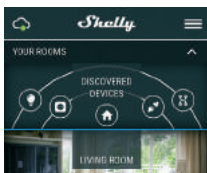

**Step 5:**  
Enter Discovered Devices and choose the Device you want to include in your account.



**Step 6:**  
Enter a name for the Device (in the Device Name field). Choose a Room, in which the Device has to be positioned. You can choose an icon or add a picture to make it easier to recognize. Press "Save Device".



**Step 7:**  
To enable connection to the Shelly Cloud service for remote control and monitoring of the Device, press "YES" on the following pop-up.

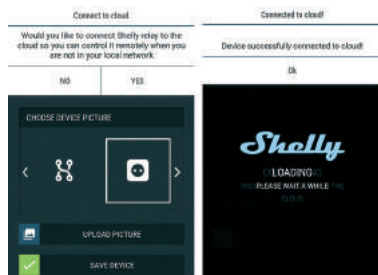

### Shelly Devices Settings

After your Shelly device is included in the app, you can control it, change its settings and automate the way it works. To switch the relay of the Device on and off, use the respective Power button. To enter at the Details menu of the respective Device, simply click on its name. From the details menu you may control the Device, as well as edit its appearance and settings.



### Details menu

Here you will see the momentary:

- Consumption - in Watts
- Voltage - in Volts
- Reactive power - in Volt-Ampere Reactive (VAR)
- Power Factor - in the range of -1 to 1

Below that you will see the history graph for the last year for:

- Consumption\*
- Voltage -with a lowest and highest measurement

*\*If you have connected your solar panel to Shelly EM, it will be shown in green color.*

### Settings

#### Timer

**Manage the power supply automatically:**  
**Auto OFF:** After turning on, the power supply will automatically shutdown after a predefined time (in seconds). A value of 0 will cancel the timer.  
**Auto ON:** After turning off, the power supply will be automatically turned on after a predefined time (in seconds). A value of 0 will cancel the timer.

#### Weekly Schedule

**This function requires an internet connection.**  
 Shelly receives actual information about the time of sunrise and sunset in your area.  
 Shelly may turn on/off automatically at a predefined time, at sunrise/sunset, or at a specified time before or after sunrise/sunset.

#### Internet/Security

**WiFi Mode - Client:** Allows the device to connect to an available WiFi network. After typing the details in the respective fields, press Connect.  
**WiFi Client Backup:** Allows the device to connect to an alternative WiFi network, if the primary is not available. After typing the details in the respective fields, press Set.  
**WiFi Mode - Access Point:** Configure Shelly to create a Wi-Fi Access point. After typing the details in the respective fields, press Create Access Point.  
**Cloud:** Enable or Disable connection to the Cloud service.  
**Restrict Login:** Restrict the web interface of Shelly with a Username and Password. After typing the details in the respective fields, press Restrict Shelly.

#### Settings

**Current Transformer Type:**  
 You can select the type of current transformer that you are using.  
**Power On Default Mode**  
 This sets the default output state when Shelly is powered.  
**ON:** Configure Shelly to turn ON, when it has power.  
**OFF:** Configure Shelly to turn OFF, when it has power. Restore Last Mode: Configure Shelly to return to last state it was in, when it has power.  
**Firmware Update**  
 Update the firmware of Shelly, when a new version is released.  
**Time Zone and Geo-location**  
 Enable or Disable the automatic detection of Time Zone and Geo-location.  
**Factory Reset**  
 Return Shelly to its factory default settings.  
**Device Information**  
 Here you can see the:

- Device ID - Unique ID of Shelly
- Device IP - The IP of Shelly in your Wi-Fi network
- Device Type - The type of your Shelly device
- WiFi Name - The name (SSID) of the WiFi network to which your Shelly is connected
- WiFi Signal - The signal strength of the WiFi network to which your Shelly is connected

#### Edit Device

From here you can edit:

- Device Name
- Device Room
- Device Picture

When you are done, press **Save Device**.  
 Some of the features of the Shelly Cloud mobile application are available at <https://my.shelly.cloud/> as well.

## The Embedded Web Interface

Even without the mobile app, Shelly can be set and controlled through a browser and WiFi connection of a mobile phone, tablet or PC.

### ABBREVIATIONS USED:

**Shelly-ID** - the unique name of the Device. It consists of 6 or more characters. It may include numbers and letters, for example **35FA58**.  
**SSID** - the name of the WiFi network, created by the Device, for example **Shellyem-35FA58**.  
**Access Point (AP)** - the mode in which the Device creates its own WiFi connection point with the respective name (SSID).  
**Client Mode (CM)** - the mode in which the Device is connected to another WiFi network.

## Installation/Initial inclusion

### Step 1

Install Shelly to the power grid following the schemes described above and place it into the console. After turning the power on Shelly will create its own WiFi network (AP).  
**WARNING:** In case the Device has not created its own WiFi network with SSID like **shellyem-35FA58** check if you have connected Shelly correctly by the schemes described above. If you do not see an active WiFi network with SSID like **shellyem-35FA58**, reset the Device. In order to reset the device, you will need physical access to it. On the back of the device, you should see a button. Press and hold it for 10 seconds. Shelly should return to AP Mode. If not, please repeat or contact our customer support at: [support@shelly.cloud](mailto:support@shelly.cloud)

### Step 2

When Shelly has created an own WiFi network (own AP), with name (SSID) such as **Shellyem-35FA58**. Connect to it with your phone, tablet or PC.

### Step 3

Type **192.168.33.1** into the address field of your browser to load the web interface of Shelly.

## General - Home Page

This is the home page of the embedded web interface. Here you will see information about:

- Current electrical consumption of Channel 1
- Power Factor of Channel 1
- Current electrical consumption of Channel 2
- Power Factor of Channel 2
- Voltage
- Power Button
- Connection to Cloud
- Present time
- Settings

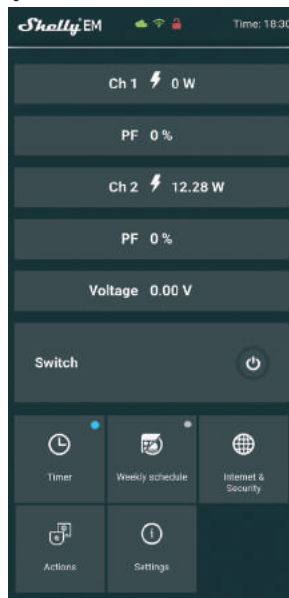

### Timer

To manage the power supply automatically, you may use:  
**Auto OFF:** After turning on, the power supply will automatically shutdown after a predefined time (in seconds). A value of 0 will cancel the timer.  
**Auto ON:** After turning off, the power supply will be automatically turned on after a predefined time (in seconds). A value of 0 will cancel the timer.

### Weekly Schedule

**This function requires an internet connection.**  
 Shelly receives actual information about the time of sunrise and sunset in your area.  
 Shelly may turn on/off automatically at a predefined time, at sunrise/sunset, or at a specified time before or after sunrise/sunset.

### Internet/Security

**WiFi Mode - Client:** Allows the device to connect to an available WiFi network. After typing the details in the respective fields, press Connect.  
**WiFi Client Backup:** Allows the device to connect to an alternative WiFi network, if the primary is not available. After typing the details in the respective fields, press Set.  
**WiFi Mode - Access Point:** Configure Shelly to create a Wi-Fi Access point. After typing the details in the respective fields, press Create Access Point.  
**Restrict Login:** Restrict the web interface of Shelly with a Username and Password. After typing the details in the respective fields, press Restrict Shelly.  
**SNTP Server:** You can change the default SNTP server. Enter the address, and click Save.  
**Advanced - Developer Settings:** Here you can change the action execution:

- Via CoAP (CoIoT)
- Via MQTT

**Cloud:** Enable or Disable connection to the Cloud service.

### Settings

**Power On Default Mode**  
 This sets the default output state when Shelly is powered.  
**ON:** Configure Shelly to turn ON, when it has power.  
**OFF:** Configure Shelly to turn OFF, when it has power. Restore Last Mode: Configure Shelly to return to last state it was in, when it has power.  
**Current Transformer Type:**  
 You can select the type of current transformer that you are using.  
**Firmware Update**  
 Update the firmware of Shelly, when a new version is released.  
**Time Zone and Geo-location**  
 Enable or Disable the automatic detection of Time Zone and Geo-location.  
**Set Date/Time**  
 You can manually set the Date and time for your Shelly device.  
**Factory Reset:** Return Shelly to its factory default settings.  
**Device Reboot:** Reboots the Device.  
**Device Info:** Shows your device ID.  
 In Client Mode shows also your WiFi network name and WiFi signal strength.

### Description of Shelly EM values:

**1. Power Consumption**  
 This is the power which is actually consumed or utilized in an AC Circuit is called True power, Active power or Real power. It is measured in kilo watt (kW) or mega Watt (MW). It is the actual outcomes of the electrical system which runs the electric circuits or loads. This is the energy which you are paying. It is shown in blue color in the history graph.  
 If you have solar panel and sell energy, you will see this power with "negative" value. It is shown in green color in the history graph.  
**2. Reactive power:**  
 This is the power that flows back and forth, it moves in both the direction in the circuit or react upon itself. The Reactive power is measured in Volt-Ampere reactive (VAR), Kilo Volt-Ampere reactive (kVAR) or Mega Volt-Ampere reactive (MVAR). You are not being charged for this energy.  
**3. Power Factor:**  
 The power factor of an AC electrical circuit is defined as the ratio of the real power absorbed by the load to the apparent power flowing in the circuit, and is a dimensionless number in the closed interval of -1 to 1. A power factor of less than 1 indicates the voltage and current are not in phase, reducing the instantaneous product of the two. In a perfect situation the Power Factor is close to 1.  
**4. Voltage:**  
 Voltage, also called electromotive force, is a quantitative expression of the potential difference in charge between two points in an electrical field.

You can download your history by going to <https://my.shelly.cloud/> in a browser on a PC.

**Manufacturer:** Allterco Robotics EOOD  
**Address:** Sofia, 1407, 103 Cherni Vrah Blvd.  
**Tel.:** +359 2 988 7435  
**E-mail:** [support@shelly.cloud](mailto:support@shelly.cloud)  
<http://www.Shelly.cloud>

The Declaration of Conformity is available at: <https://Shelly.cloud/declaration-of-conformity/>

Changes in the contact data are published by the Manufacturer at the official website of the Device:

<http://www.shelly.cloud>  
 The User is obliged to stay informed for any amendments of these warranty terms before exercising his/her rights against the Manufacturer.  
 All rights to trademarks of Shelly®, and other intellectual rights associated with this Device belong to Allterco Robotics EOOD.

