

SONOFF

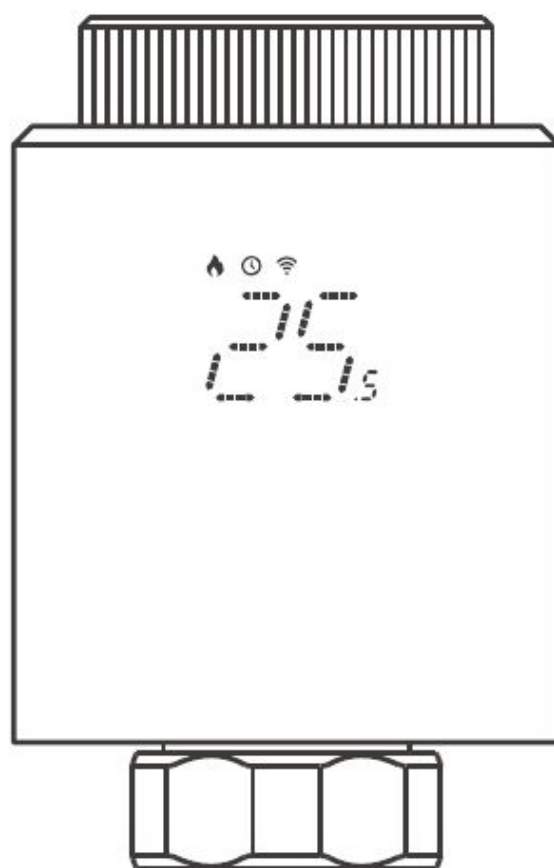

TRVZB

User manual V1.1



Thermostatic Radiator Valve



<https://sonoff.tech/product-review/tutorial/adapter-selection-guide/>





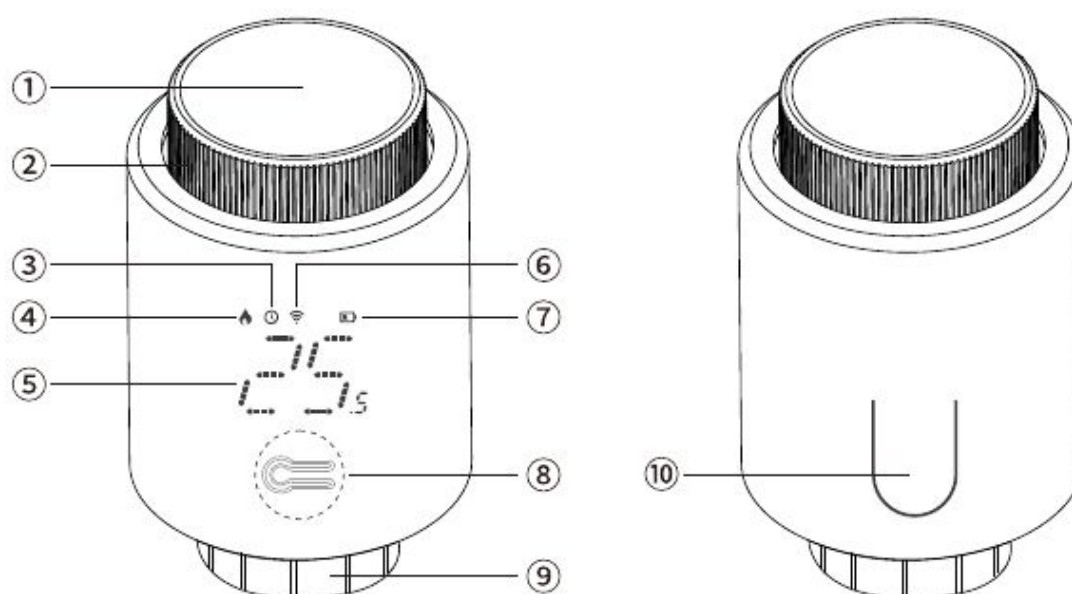





Remove the old thermostatic faucet and check if a valve adapter is needed, then scan the QR code or enter the URL to select the valve adapter.

Product introduction



- | | |
|----------------------|--|
| ① Middle button | ⑥ Internet connection |
| ② Rotary knob | ⑦ Low battery |
| ③ Auto | ⑧ Configuration key (under the dismountable shell) |
| ④ Heating | ⑨ Heating valve interface |
| ⑤ Target temperature | ⑩ Battery case latch |

Screen display and introduction

Screen display	Introduction
	<p>Window opening detection function</p> <p>The device will automatically identify whether the window is opened after you enter the app interface to enable the window opening detection function. When cold air is detected and the temperature drops more than 1.5 °C within 4.5 minutes, the window opening function will be enabled. Alongside the enabling of the function, the screen displays "  " and the temperature is set at 12 °C.</p> <p>Note: After the window opening function is enabled, the following operations will disable the window opening function:</p> <ol style="list-style-type: none"> 1. Temperature setting operation on App or device. 2. Temperature rises by more than 1.5°C within 4.5 minutes. 3. No operation on App or device within 30 minutes.
	<p>Anti-calcification function</p> <p>The temperature control valve will perform a routine calcium removal operation at 12:00 am every Monday to prevent calcification of the valve. During the operation, the screen will display "  ".</p>
	<p>Child lock function</p> <p>Press "Middle button" for 3 seconds, then the screen will display "  ", with child lock enabled. After the screen is locked, press "Middle button" for 3 seconds, then the "  " on the screen will disappear, with child lock disabled.</p>
	<p>When heating is not needed in winter, turn knob counterclockwise () to the "  " icon, then the device valve is closed and the antifreeze function is enabled.</p> <p>Note: After the antifreeze function is enabled when the room temperature is below 5 °C, the function will be enabled to prevent the radiator from being damaged by freezing. The function will be disabled when the room temperature exceeds 7 °C.</p>
	<p>Low battery (Battery needs to be replaced with a new one within 1 week)</p>

Features

With SONOFF Thermostatic Radiator Valve, you can control and reach the temperature you want more accurately. It allows remote control and timing. The window opening detection function helps you save energy and avoid additional energy waste. The matching adapters can be installed on almost any valve.



Remote Control



Smart Timing



Precise Temperature Control



Historical Data Record



Child Safety Lock



Open Window Detection

Pairing process

1. Power on the device

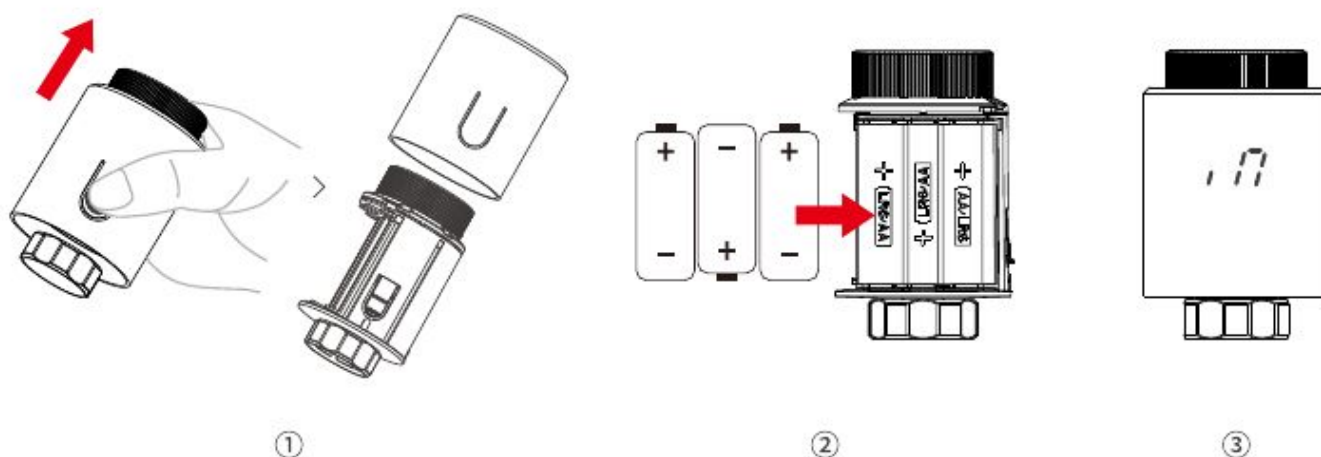

- ① Press the battery compartment latch while taking out the shell.
- ② Load the battery.
- ③ After powering on, the screen displays "17" and flashes.

2. Device installation

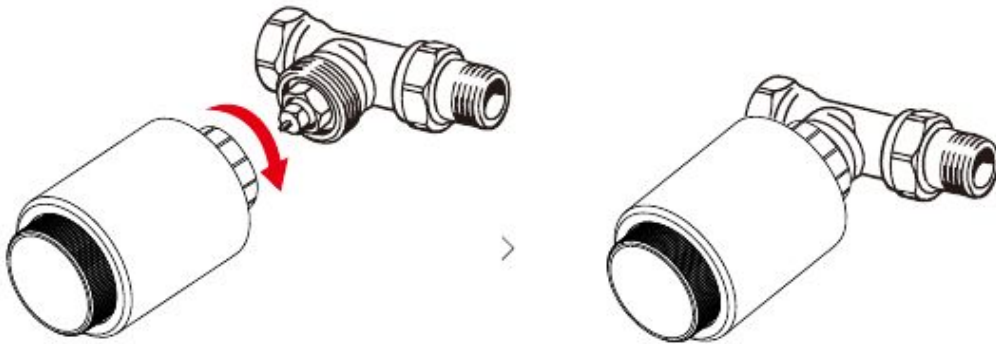

When " , 7 " stops flashing, install the device to the valve interface.

ⓘ If the screen displays " FS " or " Ad ", press the middle button and " , 7 " will display again.

3. Device debugging

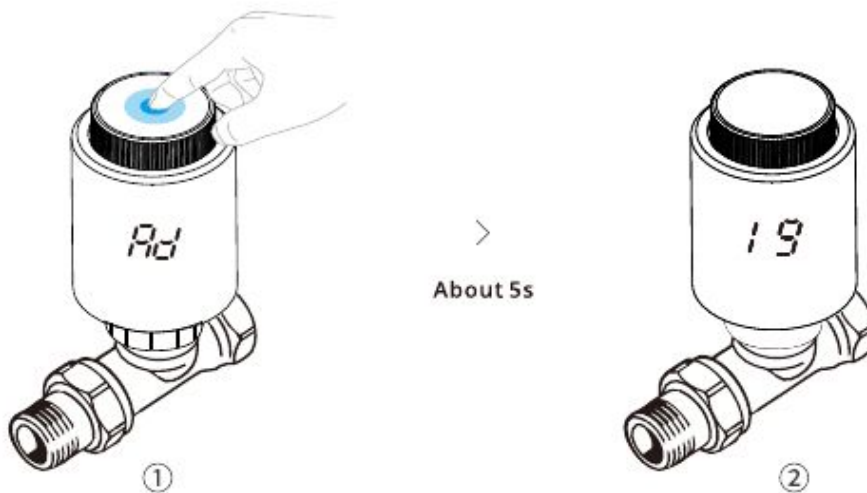



Short press the middle button, and " Ad " will flash (Figure ①). Wait for about 5 seconds, and the device will display the initialization interface (Figure ②), which means that debugging is completed.

4. Download the eWeLink App & Add SONOFF Zigbee gateway.

ⓘ The device can work with other gateways supporting Zigbee 3.0 wireless protocol. Detailed information is in accordance with the final product.

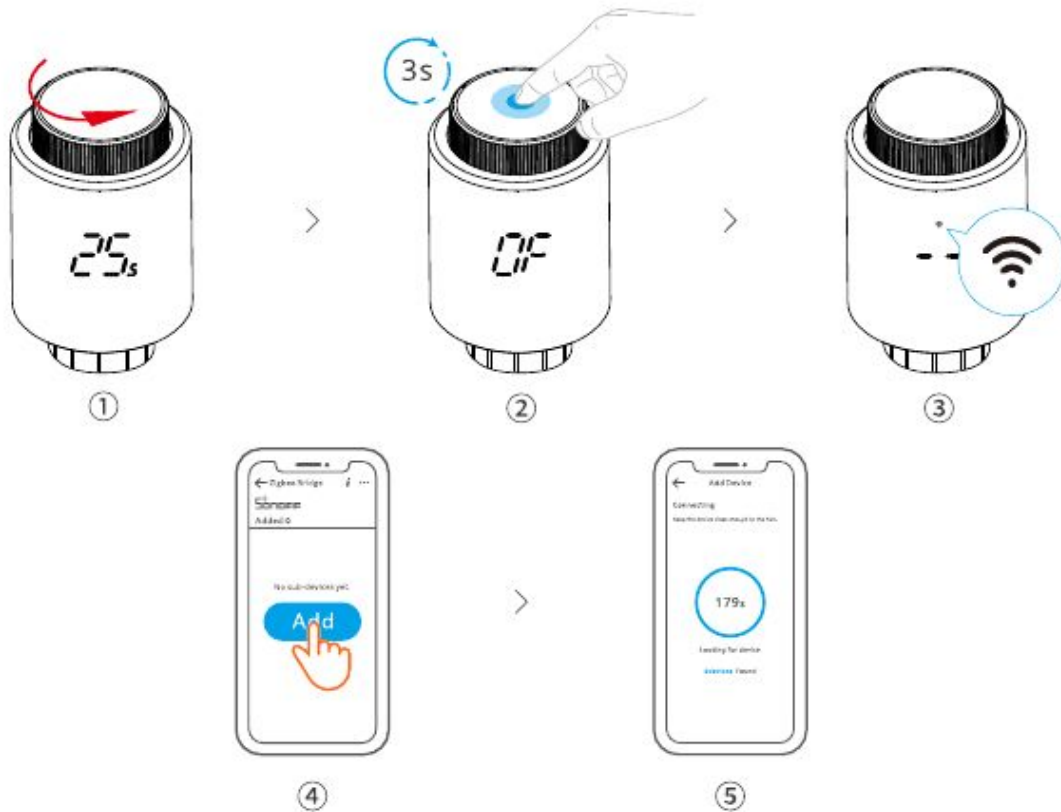
5. Add the device to Zigbee gateway



In manual mode, turn the knob counterclockwise. When the screen displays " *OF* ", press and hold the middle button for 3 seconds and the screen icon "  " flashes. Now the device enters Pairing mode, then open the App and add the device in the gateway homepage.

- ⓘ If the device fails to pair with the gateway within 3 minutes after it enters Pairing mode, the device will exit the pairing status. If you want to pair again, please press and hold the middle button for 3 seconds until the icon " *OF* " flashes when the screen shows "  ".

Temperature control mode

The device supports auto mode and manual mode. Shortly press "Middle button" to switch between the two modes.

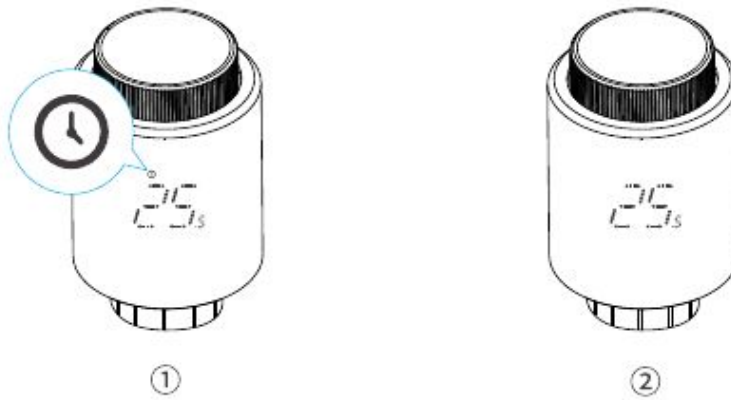

Auto mode:

When "🕒" is displayed on screen, it means the auto mode is on (Picture ①),

Manual mode:

When "🕒" disappears on screen, it means the manual mode is on (Picture ②).

⚠ Device pairing operation must be done in manual mode.

Screen display rotation

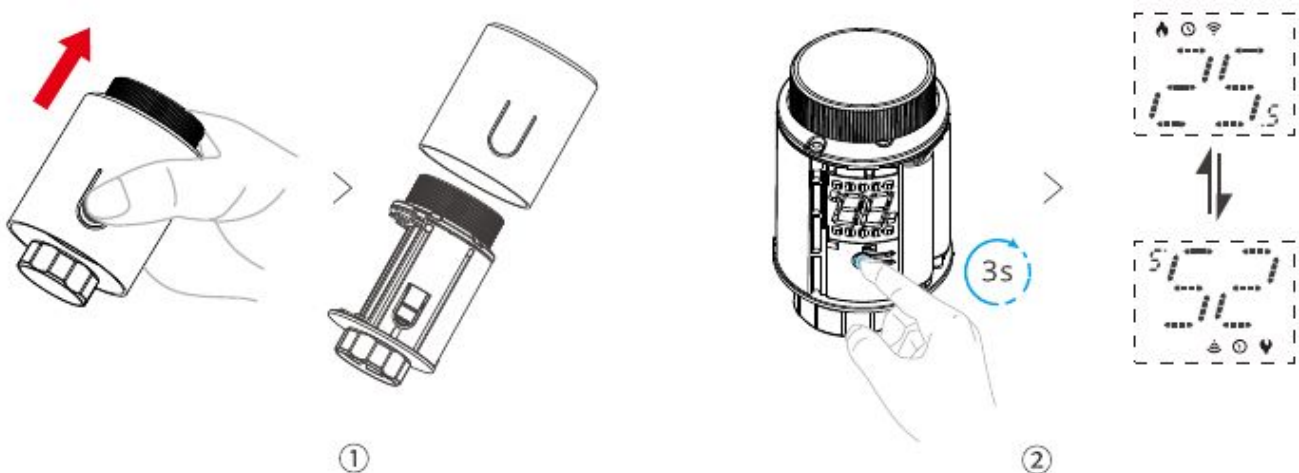

① Dismount the shell,

② Press "Configuration key" for 3 seconds to change the screen display direction.

Specifications

Model	TRVZB
Input	4.5V  (3x1.5V AA Batteries)
Battery model	1.5V LR6 Alkaline AA Battery
Wireless connection	Zigbee 3.0
Threaded connection	M30x1.5mm
Temperature setting range	4°C-35°C
Working temperature	-10°C~50°C
Working humidity	5%-95% RH Non-condensing
Color	White
Casing material	PC
Product dimension	59.4x59.4x95mm
Disconnection means	Type 1.B
Pullution degree	2
Rated impulse voltage	500V

Error codes, problems and solutions

Error code	Problem	Solution
<i>F0</i>	Abnormal temperature sensor	Contact aftersales staff
<i>F1</i>	Slow valve operation	Check installation status and heating valve
<i>F2</i>	Excessively wide adjustment range	Check whether temperature controller is fastened
<i>F3</i>	Excessively small adjustment range	Check heating valve
<i>F4</i>	Battery runs out	Replace battery
<i>F5</i>	No valve detected	Check whether valve is installed

Factory reset



Press "Middle button" for a longer time and at the same time put batteries in, then the screen displays "FR" and blinks for 3 seconds. After that, the device is reset to factory settings and is automatically restarted.

ⓘ All previous settings will be removed after the device is reset to factory settings.